

T 1-2 = 7,795 in
T 2-3 = 9,331 in

A-A (1:1)

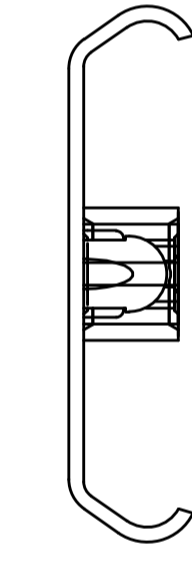

511-01-S23-TA1

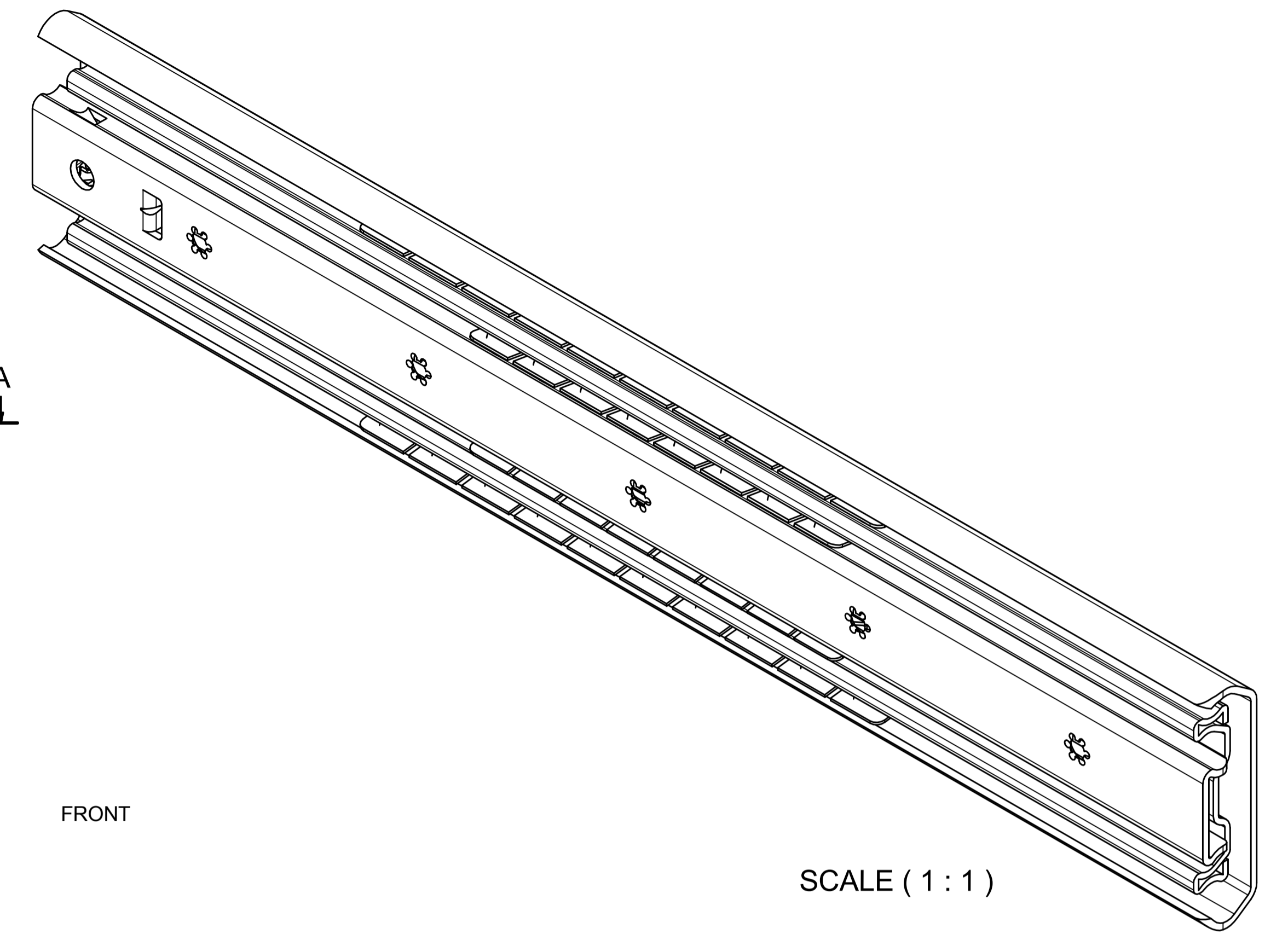
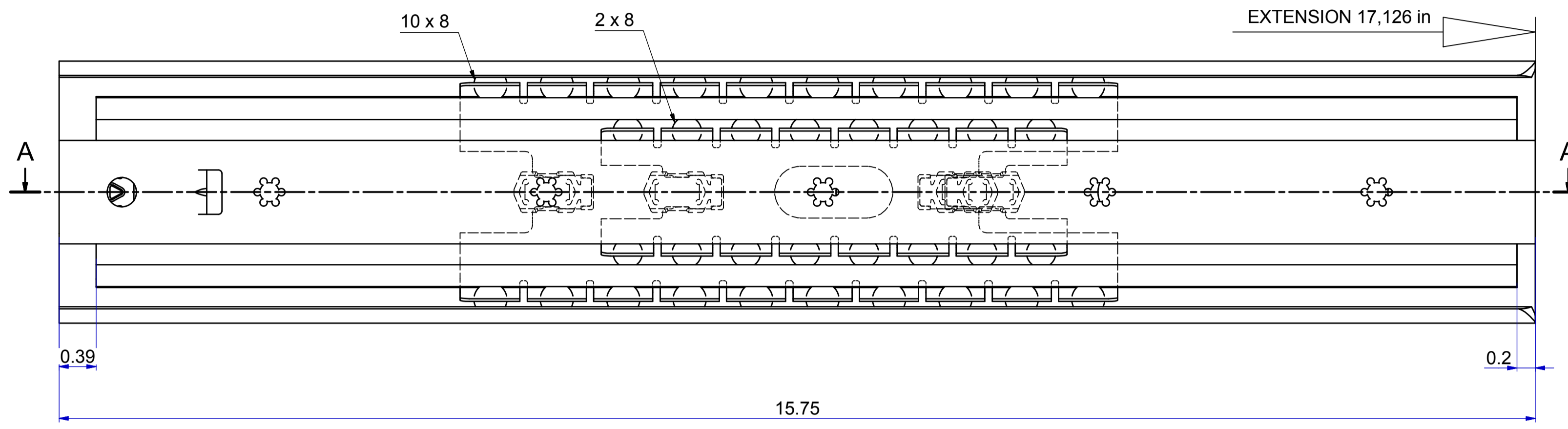
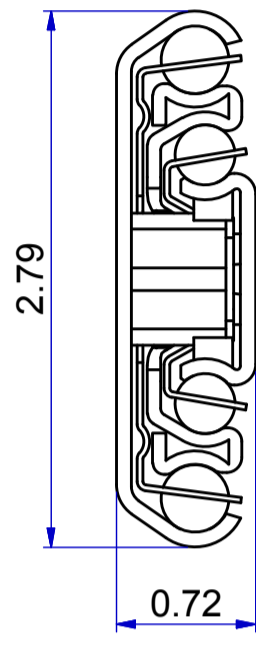
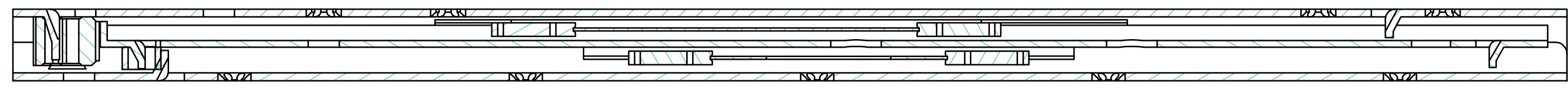
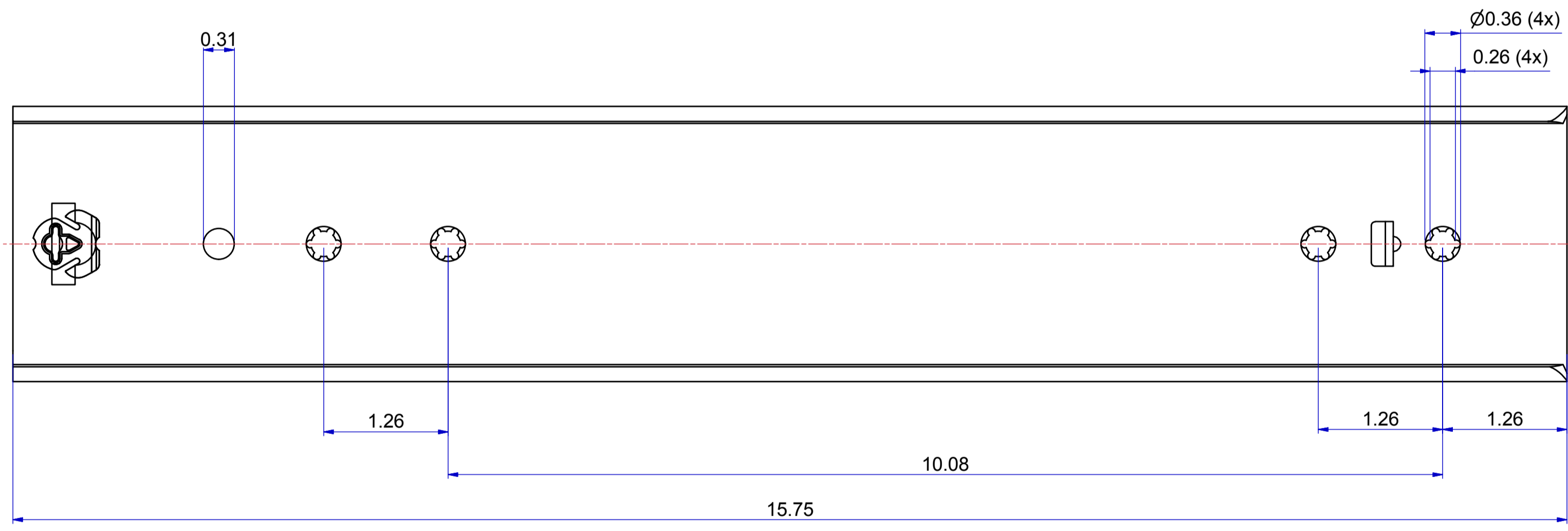

513-01-S23-TA3

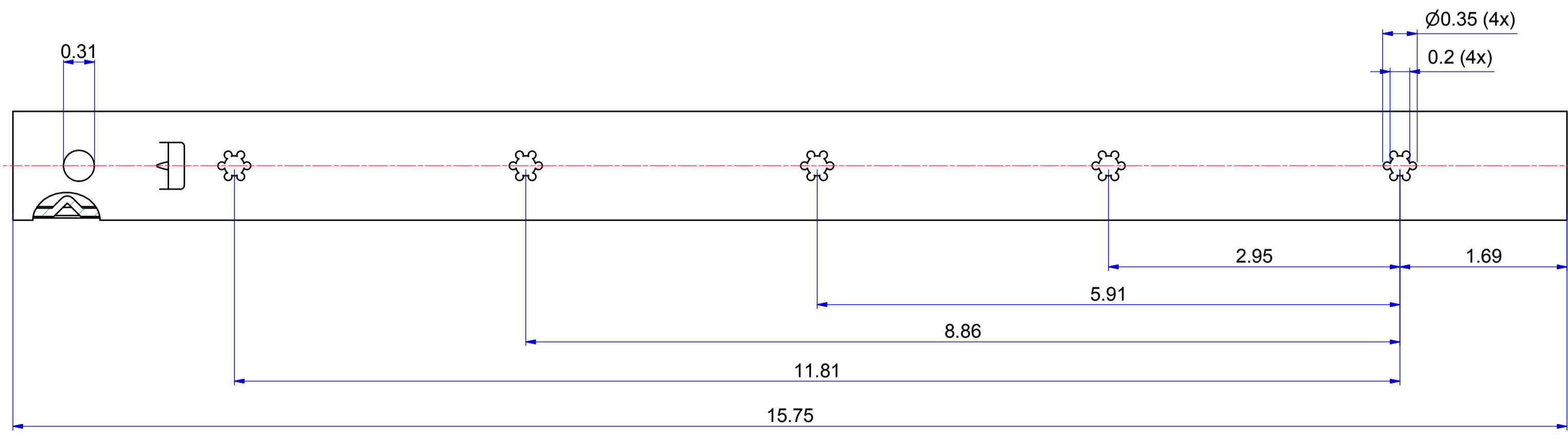

Released for Production

DIMENSIONS ARE CALCULATED FROM METRIC VALUES
THOMAS REGOUT B.V. RESERVES THE RIGHT TO ALTER NON-CUSTOMER
SPECIFICATIONS WITHOUT NOTICE

Designer	Gen.Tol.Dim.	Third angle projection	Material	Generic
Date	26-10-2015	Gen.Tol.Angle	Treatment	
Approver	Gen.Roughness		Draw type	Fabrication
Date	Units		Inch/deg	Scale
			Type	Model No. E000036280

Description
TITAN 400 / 435 (18,4mm) [15.75"/17.13"(0.724")]
Released for Production

Format		Item No.	Revision
A1		101-S23_Inch	00